

MID WEST PRODUCTS, INC.

LOG CART – MODEL LC-R08e



Owner's Manual and Parts List

SAVE THIS MANUAL

You will need this manual for the safety instructions, assembly instructions and parts list. Put it in a safe, dry place for future reference.

Additional Information/Link to PDF Copy of this Manual:



WARNING

- Read instructions and Warnings before set up and use.
- Check to insure product is not damaged prior to use. If product is damaged, do not use.
- Do not exceed cart's weight capacity of 200 lb.
- Do not exceed each tire's maximum permissible inflation pressure of 30 psi.
- Only use product as intended. Do not attempt to jump or stand on product.
- Not for use by unsupervised children.

Log Cart – Model LC-R08e

- Please read and understand these Instructions before assembling your Log Cart.
- Check that you have all components.
- 1/2" and 9/16" Wrenches required for assembly.

Assembly Instructions:

Step 1: Attach Top Handle/Front Support (#1) by inserting into the Side Frames (#3) and securing using two each Bolts (#6), Flat Washer (#11), Lock Washer (#10), and Nut (#7). Insert Wheel Axle (#5) between the two Side Frames (#3). Do not completely tighten Bolts and Nuts until told to do so.







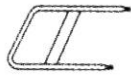

Step 2: Attach Handle/Front Support (#1) by inserting into opposite end of Side Frames (#3) and securing using two

each Bolts (#6), Flat Washer (#11), Lock Washer (#10), and Nut (#7).

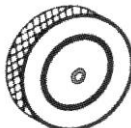
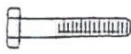
Step 3: Insert Axle (#5) through one of the Sides (#3), then slide on two Big Washers (#8) before sliding the Axle (#5) through the other Side (#3). Center Axle (#5), Slide Big Washers (#8) [one to each side] out against the Sides (#3). Secure Axle (#5) with a Cotter Pin (#9) in the hole just inside the Big Washers (#8). Tightness.

Step 4: Attach one Wheel (#4) on each side of the Axle (#5) and secure with Washers (#9) and Cotter Pin (#8).

Step 5: Now Tighten all parts that are using Bolts (#6) and Nuts (#7) as shown in the Diagram. Assembly is now complete!

Key	Part No.	Description	Image	Qty
1	52-0001	Handle/Front Support		2
3	52-0003	Sides		2
4	52-0004	Wheel & Tire		2
5	52-0005	Axle		1
6	52-0006	Bolt		4
7	52-0007	Nut		4
8	52-0008	Cotter Pin		4
9	52-0009	Big Washer		4
10	52-0010	Lock Washer		4
11	52-0011	Flat Washer		4

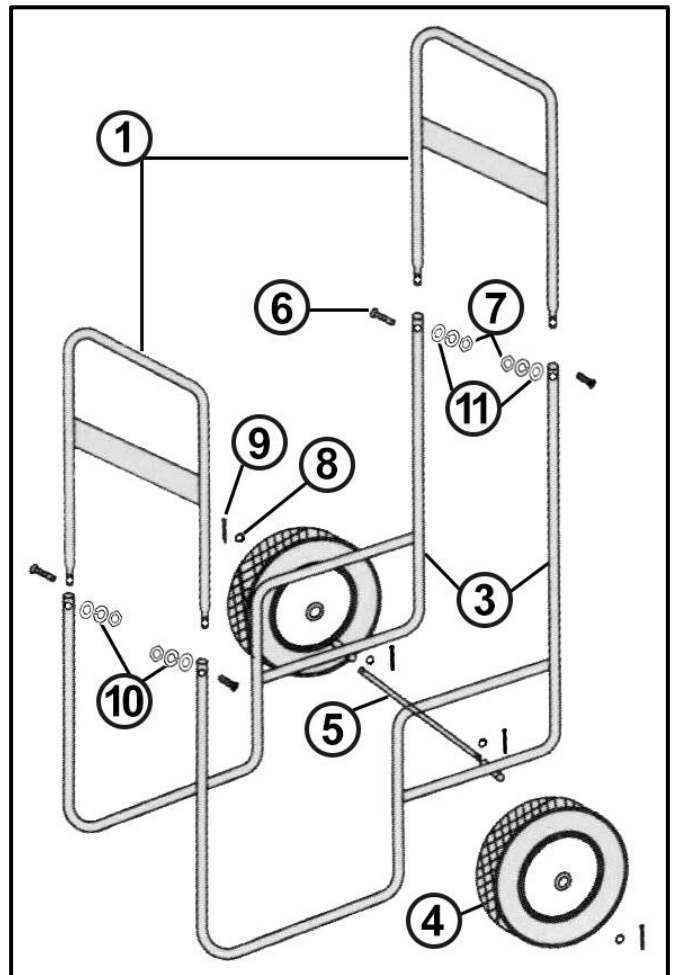

INSTRUCTIONS FOR ORDERING PARTS

(Minimum Parts Order Charge \$20.00)

1. Address all parts orders or correspondence regarding customer service to one of the following:
Parts Dept. Phone: (937) 337-3641
Mid West Products, Inc.
P.O. Box 301 E-mail: Parts@Mid-West-Products-Inc.com
Phillipsburg, OH 45354 Website: www.Mid-West-Products-Inc.com
2. Write your name and address plainly (print or type).
3. Explain where and how to ship.
4. Give model number of unit.
5. Give part number from parts list, as well as a description, including color, of the part and the quantity you need.
6. Inspect all shipments you receive. If any parts are damaged or missing, file a claim with the carrier before accepting.
7. If you are returning parts, be sure to include WITH THE SHIPMENT a list of the parts with your name and address.
8. All orders for repair and replacement parts will be shipped when paid with Master Card, Visa, or personal check/money order. Prices subject to change without notice.

GUARANTEE

The merchandise you have purchased from us has been carefully engineered and manufactured under Mid West Products rigid quality standards and should give you satisfactory, dependable operation. However, like all mechanical merchandise, it may occasionally require adjustment or maintenance. Should you need technical assistance, please contact MID WEST PRODUCTS.

OTHER LAWN & GARDEN TOOLS FROM MID WEST PRODUCTS, INC.

WOODEN UTILITY CARTS — GC-20 OR GC-26

It has a gate that lifts out to unload bulky loads like mulch, soil, gravel, firewood or waste and also allow it to carry longer items. Once you have one, you'll wonder what you ever did without it!

The Standard-Duty Utility Cart has two 20" Pneumatic Wheels and a cargo capacity of 6.5 cubic feet or up to 300 pounds.

The Heavy-Duty Utility Cart has two 26" Pneumatic Wheels and a cargo capacity of 11.3 cubic feet or up to 400 pounds.



VEGETABLE GARDEN ROW SEED PLANTER — GSF-31M

- ALL-IN-ONE item that can simultaneously Plant and Fertilize Seeds as well as Mark Rows.
- It only weighs 14 lbs. and NO TOOLS are REQUIRED for Assembly.
- Attached Pouch for extra seed, notes, gloves, and other needed items.
- High Strength Powder Coated Steel Frame and Seed Tube.
- The unit is Rear-Wheel Belt Driven for Positive, Even Seeding and No Messy Chain to pull the seeds out of the ground.
- Includes 6 Different Seed Plates for 31 Common Variations in Seed Sizes.

31" DELUXE PUSH LAWN SWEEPER — B-319

- The "Butterfly" Handles Increase the Hamper Capacity to a Huge 8.5-Bushel.
- Big 10" Precision Molded Plastic Wheels with Ribbed Tread Rubber Tire...Makes this Unit Easy to Push.
- The Rear Swivel Casters Help Make this Easy to Maneuver.
- Our Easy to Operate One-Hand "Squeeze Me" Height Adjustment Makes it Easy to go From Grass to Pavement.
- The Removable Hamper Allows for Easy Dumping and Fold Away Storage.



HIGH WHEEL CULTIVATOR — HWC-243A

- 24" Steel Wheel For Easy Handling
- Special Selection of 3 Tools (Mol-board Plow, Reversible Shovel, Welded Five-Tine Cultivator)
- Slotted Foot For Plow Attachments Enables Easy Adjustment of Cutting Depth and Angle
- Handle Folds Easily For Storage or Transportation